

PR[®]



6 3 3 5

**2-Wire HART[®]
Transmitter**

No. 6335V109-IN
From ser. no. 100924000



SIGNALS THE BEST

- DK** ▶ PR electronics A/S tilbyder et bredt program af analoge og digitale signalbehandlingsmoduler til industriel automation. Programmet består af Isolatorer, Displays, Ex-barrierer, Temperaturtransmittere, Universaltransmittere mfl. Vi har modulerne, du kan stole på i selv barske miljøer med elektrisk støj, vibrationer og temperaturudsving, og alle produkter opfylder de strengeste internationale standarder. Vores motto »Signals the Best« er indbegrebet af denne filosofi – og din garanti for kvalitet.
- UK** ▶ PR electronics A/S offers a wide range of analogue and digital signal conditioning modules for industrial automation. The product range includes Isolators, Displays, Ex Interfaces, Temperature Transmitters, and Universal Modules. You can trust our products in the most extreme environments with electrical noise, vibrations and temperature fluctuations, and all products comply with the most exacting international standards. »Signals the Best« is the epitome of our philosophy – and your guarantee for quality.
- FR** ▶ PR electronics A/S offre une large gamme de produits pour le traitement des signaux analogiques et numériques dans tous les domaines industriels. La gamme de produits s'étend des transmetteurs de température aux afficheurs, des isolateurs aux interfaces SI, jusqu'aux modules universels. Vous pouvez compter sur nos produits même dans les conditions d'utilisation sévères, p.ex. bruit électrique, vibrations et fluctuations de température. Tous nos produits sont conformes aux normes internationales les plus strictes. Notre devise »SIGNALS the BEST« c'est notre ligne de conduite - et pour vous l'assurance de la meilleure qualité.
- DE** ▶ PR electronics A/S verfügt über ein breites Produktprogramm an analogen und digitalen Signalverarbeitungsmodulen für die industrielle Automatisierung. Dieses Programm umfasst Displays, Temperaturtransmitter, Ex- und galvanische Signaltrenner, und Universalgeräte. Sie können unsere Geräte auch unter extremen Einsatzbedingungen wie elektrisches Rauschen, Erschütterungen und Temperaturschwingungen vertrauen, und alle Produkte von PR electronics werden in Übereinstimmung mit den strengsten internationalen Normen produziert. »Signals the Best« ist Ihre Garantie für Qualität!

2-WIRE HART® TRANSMITTER

PRETRANS 6335

CONTENTS

EC declaration of conformity	2
Application	3
Technical characteristics	3
Mounting / installation.....	3
Applications.....	4
Order: 6335	5
Electrical specifications.....	5
Connections	9
Block diagram	11
Programming.....	12
Connection of transmitters in multidrop mode.....	14
Appendix	15
ATEX Installation Drawing - 6335A.....	15
ATEX Installation Drawing - 6335D	15
IECEX installation drawing - 6335D.....	15
FM Installation Drawing No. 6335QF01	15
CSA Installation Drawing No. 6335QC02	15

EC DECLARATION OF CONFORMITY

As manufacturer

**PR electronics A/S
Lerbakken 10
DK-8410 Rønde**

hereby declares that the following product:

**Type: 6335
Name: 2-wire HART® transmitter**

is in conformity with the following directives and standards:

The EMC Directive 2004/108/EC and later amendments
EN 61326-1 : 2006

For specification of the acceptable EMC performance level, refer to the electrical specifications for the module.

The ATEX Directive 94/9/EC and later amendments

**EN 60079-0 : 2006, EN 60079-11 : 2007,
EN 60079-15 : 2005 and EN 60079-26 : 2007
ATEX certificate: KEMA 10ATEX0006 X (6335A)
ATEX certificate: KEMA 09ATEX0148 (6335D)**

Notified body

**KEMA Quality B.V. (0344)
Utrechtseweg 310, 6812 AR Arnhem
P.O. Box 5185, 6802 ED Arnhem
The Netherlands**

Rønde, 22 March 2010



Kim Rasmussen
Manufacturer's signature

2-WIRE HART® TRANSMITTER PRETRANS 6335

- *RTD, TC, Ohm, or mV input*
- *Extremely high measurement accuracy*
- *HART® communication*
- *Galvanic isolation*
- *1- or 2-channel version*

Application

- Linearised temperature measurement with Pt100...Pt1000, Ni100...Ni1000, TC or sensor.
- Difference or average temperature measurement of 2 resistance or TC sensors.
- Conversion of linear resistance variation to a standard analogue current signal, for instance from valves or Ohmic level sensors.
- Amplification of a bipolar mV signal to a standard 4...20 mA current signal.
- Connection of up to 15 channels to a digital 2-wire signal with HART® communication.

Technical characteristics

- Within a few seconds the user can program PR6335 to measure temperatures within all ranges defined by the norms.
- The RTD and resistance inputs have cable compensation for 2-, 3- and 4-wire connection.
- The 6335 has been designed according to strict safety requirements and is thus suitable for application in SIL 2 installations.
- A limit can be programmed on the output signal.
- Continuous check of vital stored data for safety reasons.
- Sensor error detection according to the guidelines in NAMUR NE 89.

Mounting / installation

- Mounted vertically or horizontally on a DIN rail. As the modules can be mounted without any distance between neighbouring units, up to 84 channels can be mounted per metre.
- **NB:** As Ex barrier for 6335D we recommend 5106B.

APPLICATIONS

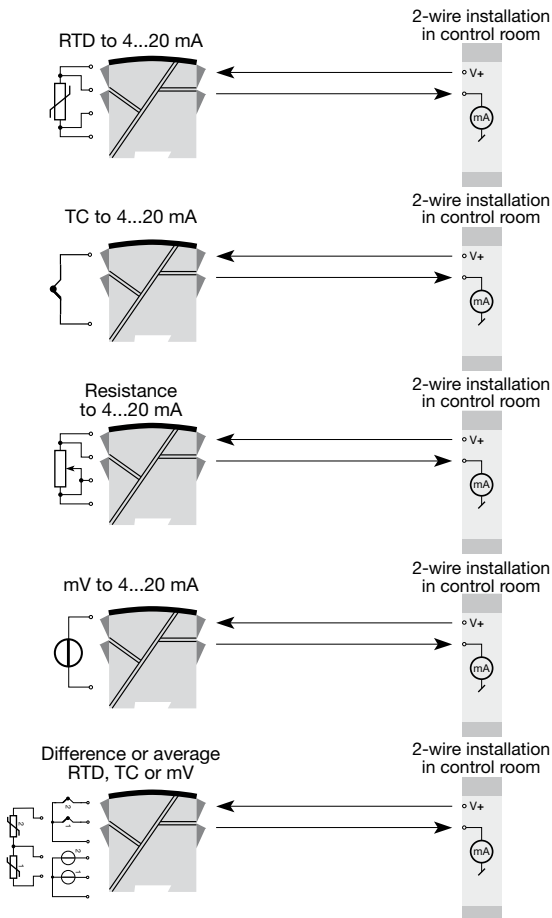

Order: 6335



Type	Version	Galvanic isolation	Channels
6335	Standard : A CSA, FM, : D ATEX & IECEx	1500 VAC : 2	Single : A Double : B

***NB!** Please remember to order CJC connectors type 5910/5910Ex (channel 1) and 5913/5913Ex (channel 2) for TC inputs with an internal CJC.

Electrical specifications

Specifications range:

-40°C to +60°C

Common specifications:

Supply voltage, DC

Standard..... 8.0...35 VDC

CSA, FM, ATEX & IECEx..... 8.0...30 VDC

Isolation voltage, test / operation 1.5 kVAC / 50 VAC

Isolation voltage, channel 1 / channel 2:

Standard..... 3.75 kVAC

CSA, FM, ATEX & IECEx..... 1500 VAC

Warm-up time..... 30 s

Communications interface Loop Link and HART®

Signal / noise ratio Min. 60 dB

Response time (programmable) 1...60 s

EEProm error check < 10 s

Signal dynamics, input..... 22 bit

Signal dynamics, output..... 16 bit

Calibration temperature..... 20...28°C

Accuracy, the greater of general and basic values:

General values		
Input type	Absolute accuracy	Temperature coefficient
All	≤ ±0.05% of span	≤ ±0.005% of span / °C

Basic values		
Input type	Basic accuracy	Temperature coefficient
Pt100 and Pt1000	$\leq \pm 0.1^{\circ}\text{C}$	$\leq \pm 0.005^{\circ}\text{C}/^{\circ}\text{C}$
Ni100	$\leq \pm 0.2^{\circ}\text{C}$	$\leq \pm 0.005^{\circ}\text{C}/^{\circ}\text{C}$
Lin. R	$\leq \pm 0.1 \Omega$	$\leq \pm 5 \text{ m}\Omega / ^{\circ}\text{C}$
Volt	$\leq \pm 10 \mu\text{V}$	$\leq \pm 0.5 \mu\text{V} / ^{\circ}\text{C}$
TC type: E, J, K, L, N, T, U	$\leq \pm 0.5^{\circ}\text{C}$	$\leq \pm 0.025^{\circ}\text{C} / ^{\circ}\text{C}$
TC type: B, R, S, W3, W5	$\leq \pm 1^{\circ}\text{C}$	$\leq \pm 0.1^{\circ}\text{C} / ^{\circ}\text{C}$

EMC immunity influence	$< \pm 0.1\%$ of span
Extended EMC immunity: NAMUR NE 21, A criterion, burst	$< \pm 1\%$ of span

Effect of supply voltage variation.....	$< 0.005\%$ of span / VDC
Max. wire size.....	1 x 1.5 mm ² stranded wire
Humidity	$< 95\%$ RH (non-cond.)
Dimensions.....	109 x 23.5 x 104 mm
Protection degree.....	IP20
Weigh (1 / 2 channels).....	145 / 185 g

Electrical specifications, inputs:

Max. offset.....	50% of selected numerical max. value
------------------	--------------------------------------

RTD and linear resistance input:

RTD type	Min. value	Max. value	Min. span	Standard
Pt100	-200°C	+850°C	10°C	IEC 60751
Ni100	-60°C	+250°C	10°C	DIN 43760
Lin. R	0 Ω	7000 Ω	10 Ω	-----

Cable resistance per wire (max.).....	5 Ω
Sensor current.....	Nom. 0.2 mA
Effect of sensor cable resistance (3- / 4-wire).....	$< 0.002 \Omega / \Omega$
Sensor error detection	Yes
Short circuit detection.....	If 0% $> 30 \Omega$

TC inputs:

Type	Min. temperature	Max. temperature	Min. span	Standard
B	+400°C	+1820°C	100°C	IEC584
E	-100°C	+1000°C	50°C	IEC584
J	-100°C	+1200°C	50°C	IEC584
K	-180°C	+1372°C	50°C	IEC584
L	-100°C	+900°C	50°C	DIN 43710
N	-180°C	+1300°C	50°C	IEC584
R	-50°C	+1760°C	100°C	IEC584
S	-50°C	+1760°C	100°C	IEC584
T	-200°C	+400°C	50°C	IEC584
U	-200°C	+600°C	50°C	DIN 43710
W3	0°C	+2300°C	100°C	ASTM E988-90
W5	0°C	+2300°C	100°C	ASTM E988-90

Cold junction compensation < ±1.0°C

External CJC with Ni100 or Pt100 $-40 \leq T_{amb.} \leq 135^\circ\text{C}$

Sensor error detection Yes

Sensor error current:

When detecting Nom. 33 µA

Else 0 µA

Short circuit detection If 0% > 5 mV

Voltage inputs:

Measurement range -800...+800 mV

Min. span 2.5 mV

Input resistance 10 MΩ

Current output:

Signal range 4...20 mA

Min. signal range 16 mA

Updating time 440 ms

(660 ms for diff.)

Fixed output signal Between 4 and 20 mA

Output signal at EEPROM error ≤ 3.5 mA

Load resistance $\leq (V_{supply} - 8) / 0.023 [\Omega]$

Load stability < ±0.01% of span / 100 Ω

Sensor error detection:

Programmable 3.5...23 mA

NAMUR NE43 Upscale 23 mA

NAMUR NE43 Downscale 3.5 mA

Of span = Of the presently selected range

Ex approval - 6335A:

KEMA 10ATEX0006 X.....	II 3 G Ex nA [nL] IIC T4...T6 or II 3 G Ex nL IIC T4...T6 or II 3 G Ex nA [ic] IIC T4...T6 or II 3 G Ex ic IIC T4...T6
ATEX Installation Drawing No.	6335QA02

Ex / I.S. approvals - 6335D:

ATEX KEMA 09ATEX0148	 II 1 G Ex ia IIC T6...T5
Max. ambient temperature for T6	40°C
Max. ambient temperature for T5	60°C
ATEX, applicable in zone.....	0, 1 or 2
ATEX Installation Drawing No.	6335QA01
IECEX KEM 10.0084	Ex ia IIC T5 Ga
IECEX Installation Drawing No.....	6335QI01
FM, applicable in.....	IS, Class I, Div. 1, Group A, B, C, D IS, Class I, Zone 0, AEx ia IIC
FM Installation Drawing No.....	6335QF01
CSA, applicable in.....	IS, Class I, Div. 1, Group A, B, C, D, Ex ia IIC IS, Class I, Zone 0, AEx ia IIC
CSA Installation Drawing No.	6335QC02

GOST R approval:

VNIIM & VNIIFTRI, Cert. no.....	See www.prelectronics.com
---------------------------------	--

Observed authority requirements:

EMC 2004/108/EC	EN 61326-1
ATEX 94/9/EC.....	EN 60079-0, EN 60079-11, EN 60079-15, EN 60079-26
IECEX.....	IEC 60079-0, -11, 26
FM	3600, 3611, 3610
CSA, CAN / CSA	C22.2 No. 157, E60079-11, UL 913

Standard:

CONNECTIONS

Inputs:

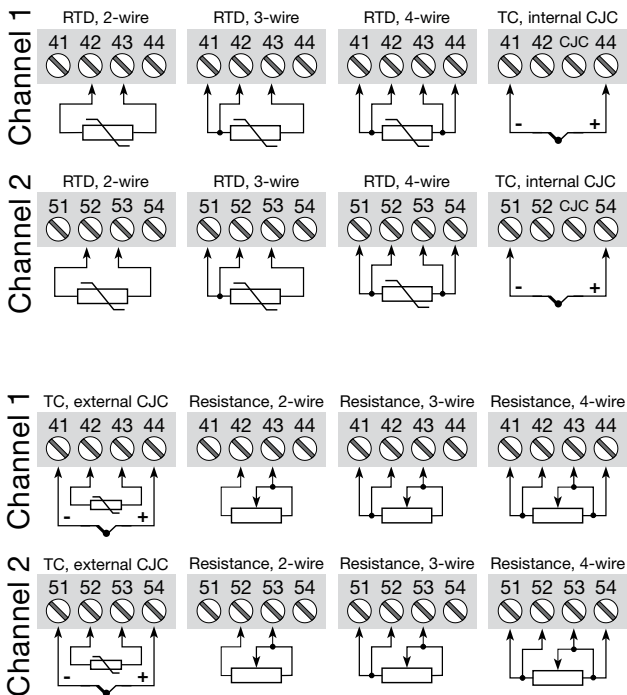

CONNECTIONS

Inputs:

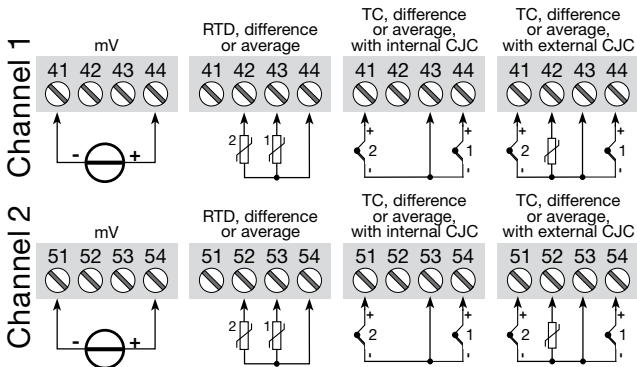

Outputs:

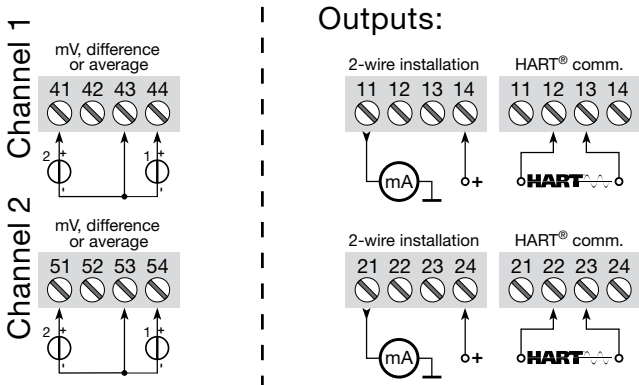

BLOCK DIAGRAM

PROGRAMMING

PRetrans 6335 can be configured in the following 3 ways:

1. With PR electronics A/S' communications interface Loop Link and PReset PC configuration software.
2. With a HART® modem and PReset PC configuration software.
3. With a HART® communicator with PR electronics A/S' DDL driver.

1: Loop Link

For programming please refer to the drawing below and the help functions in PReset.

When communicating with non-installed modules, connectors 11, 12, 13, 14 (channel 1) and 21, 22, 23, 24 (channel 2) can be dismantled in the safe area to connect the terminals of the communications interface to the pins.

Loop Link is not approved for communication with modules installed in hazardous (Ex) area.

Order: Loop Link

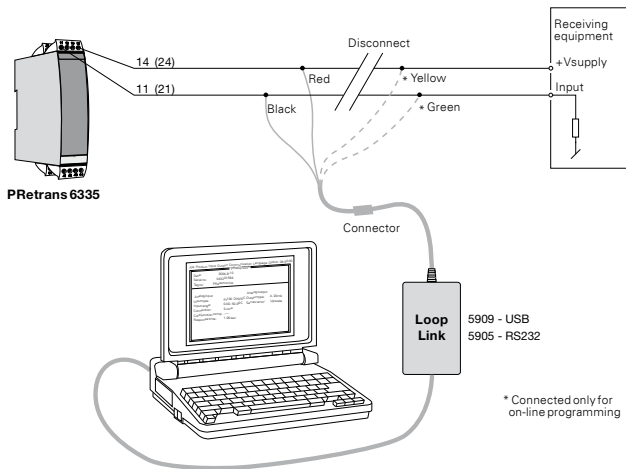

2: HART® modem

For programming please refer to the drawing below and the help functions in PReset.

Order: HART® modem 276D

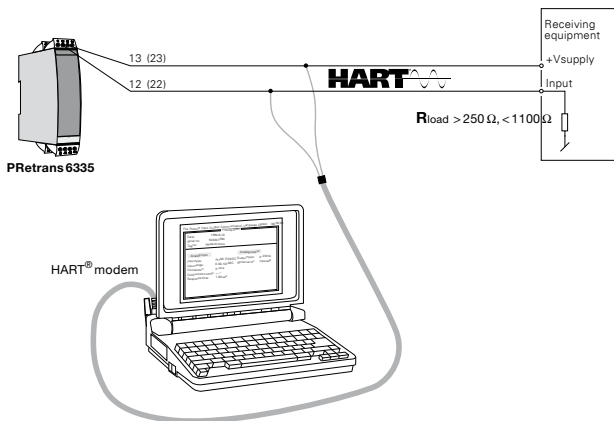

3: HART® communicator

For programming please refer to the drawing below. To get access to product-specific commands, the HART® communicator must be loaded with the PR electronics A/S DDL driver. This can be ordered either at the HART® Communication Foundation or PR electronics A/S.

Order: HART® communicator 275D

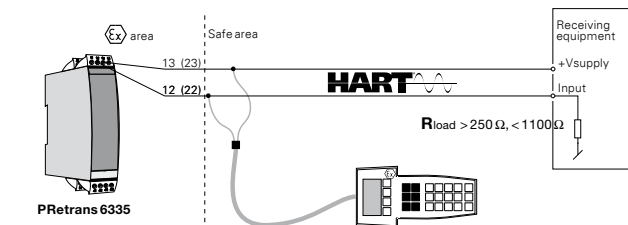

CONNECTION OF TRANSMITTERS IN MULTIDROP MODE

- The HART[®] communicator or a PC modem can be connected across AB or BC.

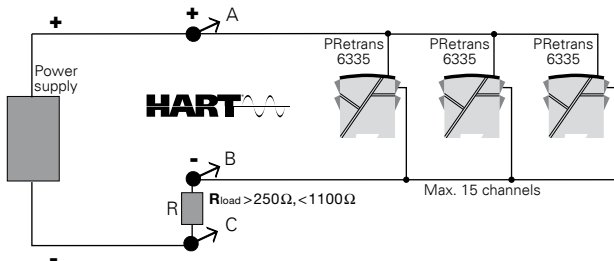

- The outputs of max. 15 transmitters can be connected in parallel for a digital HART[®] communication on 2-wires.
- Before it is connected, each transmitter must be configured with a unique number from 1 to 15. If 2 transmitters are configured with the same number, both will be excluded. The transmitters must be programmed for multidrop mode (with a fixed output signal of 4 mA). Maximum current in the loop is therefore 60 mA.
- The communication is either by means of a HART[®] communicator or a HART[®] modem.
- The PReset PC configuration software can configure the individual transmitter for multidrop mode and provide it with a unique polling address.

APPENDIX

ATEX INSTALLATION DRAWING - 6335A

ATEX INSTALLATION DRAWING - 6335D

IECEX INSTALLATION DRAWING - 6335D

FM INSTALLATION DRAWING NO. 6335QF01

CSA INSTALLATION DRAWING NO. 6335QC02

ATEX Installation drawing

For safe installation of 6335A the following must be observed. The module shall only be installed by qualified personnel who are familiar with the national and international laws, directives and standards that apply to this area.

Year of manufacture can be taken from the first two digits in the serial number.

ATEX Certificate KEMA 10ATEX 0006X

Marking



II 3 G Ex nA [nL] IIC T6..T5
II 3 G Ex nL IIC T6..T5

II 3 G Ex nA [ic] IIC T6..T5
II 3 G Ex ic IIC T6..T5

Standards EN 60079-0 : 2006, EN 60079-11 : 2007, EN 60079-15 : 2005

T5: -40°C to 60 °C

T6: -40°C to 40 °C

Terminal:

**41,42,43,44 /
51,52,53,54**

Ex nA [nL]

U_o: 9,6 VDC

I_o: 28 mA

P_o: 67 mW

L_o: 35 mH

Co: 3.5 µF

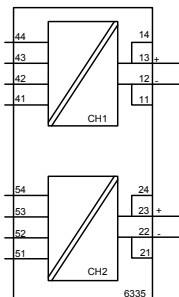

Hazardous Area Zone 2

Terminal:

11-13 / 21-23

Ex nA

U ≤ 35 VDC

I = 4 - 20 mA

Ex nL or Ex ic

U_i = 35 VDC

L_i = 10 µH

C_i = 2.0 nF

Special conditions for safe use:

For use in a potentially explosive atmosphere of flammable gasses, vapours or mists, the transmitter shall be mounted in an enclosure providing a degree of protection of at least IP54 in accordance to EN60529.

ATEX Installation drawing

6335

For safe installation of 6335D the following must be observed. The module shall only be installed by qualified personnel who are familiar with the national and international laws, directives and standards that apply to this area.

Year of manufacture can be taken from the first two digits in the serial number.

ATEX Certificate KEMA 09ATEX 0148

Marking II 1 G Ex ia IIC T6...T5

Standards EN 60079-0 : 2006, EN 60079-11 : 2007, EN 60079-26 : 2007

Hazardous area
Zone 0, 1, 2

T5: $-40 \leq T_a \leq 60^\circ\text{C}$

T6: $-40 \leq T_a \leq 40^\circ\text{C}$

Terminal:
41,42,43,44

 U_o: 9.6 VDC

 I_o: 28 mA

 P_o: 67 mW

 L_o: 35 mH

 C_o: 3.5 μF
Terminal:
51,52,53,54

 U_o: 9.6 VDC

 I_o: 28 mA

 P_o: 67 mW

 L_o: 35 mH

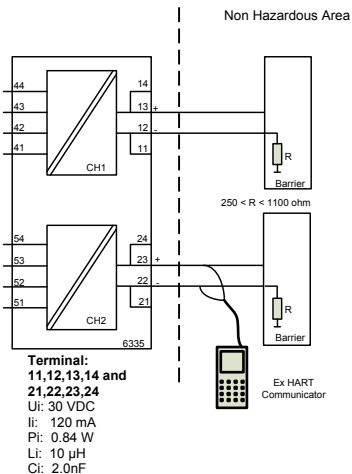
 C_o: 3.5 μF

Installation notes

The Instructions provided with the equipment shall be followed in detail to assure safe operation.

IECEx Installation drawing



For safe installation of 6335D or 6336D the following must be observed. The module shall only be installed by qualified personnel who are familiar with the national and international laws, directives and standards that apply to this area.

Year of manufacture can be taken from the first two digits in the serial number.

IECEx Certificate	IECEx KEM.10.0084
Marking	Ex ia IIC T5 Ga
Standards	IEC60079-11:2006, IEC60079-0: 2007, IEC60079-26: 2006

Hazardous area
Zone 0, 1, 2
T5: $-40 \leq T_a \leq 60^\circ\text{C}$

**Terminal:
41,42,43,44**
Uo: 9.6 VDC
Io: 28 mA
Po: 67 mW
Lo: 35 mH
Co: 3.5 μF

**Terminal:
51,52,53,54**
Uo: 9.6 VDC
Io: 28 mA
Po: 67 mW
Lo: 35 mH
Co: 3.5 μF

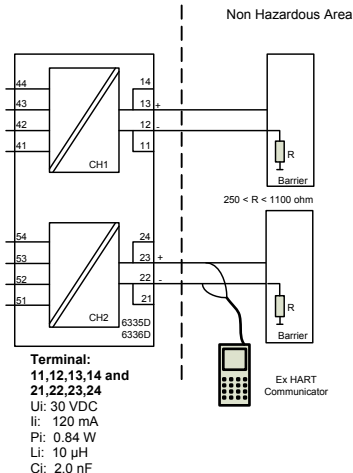

Installation notes

The Instructions provided with the equipment shall be followed in detail to assure safe operation.

Installation Drawing 6335QF01

Model 6335C, 6335D

Hazardous (Classified) Location

Class I, Division 1, Groups A, B, C, D

Class II Division 1 Groups E, F, G

Class I, Zone 0, IIC

Ambient temperature limits
T6: -40 to +60 deg. Celcius

Terminal 41, 42, 43, 44
Vt or Uo: 9.6 V
It or Io: 28 mA
Pt or Po: 67.2 mW
Ca or Co: 3.5 uF
La or Lo: 35 mH

Terminal 51, 52, 53, 54
Vt or Uo: 9.6 V
It or Io: 28 mA
Pt or Po: 67.2 mW
Ca or Co: 3.5 uF
La or Lo: 35 mH

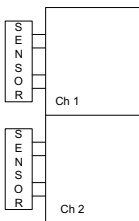

Terminal 11, 14
Vmax or Ui: 30 V
Imax or Ii: 120 mA
Pmax or Pi: 0.84 W
Ci: 1 nF
Li: 10 uH

Terminal 21, 24
Vmax or Ui: 30 V
Imax or Ii: 120 mA
Pmax or Pi: 0.84 W
Ci: 1 nF
Li: 10 uH

Non Hazardous Location

Um ≤ 250V
Voc or Uo ≤ Vmax or Ui
Isc or Io ≤ Imax or Ii
Po ≤ Pi
Ca or Co ≥ Ci + Ccable
La or Lo ≥ Li + Lcable

Um ≤ 250V
Voc or Uo ≤ Vmax or Ui
Isc or Io ≤ Imax or Ii
Po ≤ Pi
Ca or Co ≥ Ci + Ccable
La or Lo ≥ Li + Lcable

Installation notes.

The Transmitter must be installed in a suitable enclosure to meet installation codes stipulated in The National Electrical Code (ANSI-NFPA 70).

When installed in Class II locations the Transmitter shall be installed in an enclosure with a specified ingress protections of IP6X according to IEC60529 and Dust-tight conduit seals must be used.

Equipment that is FM-approved for intrinsic safety may be connected to barriers based on the ENTITY CONCEPT. This concept permits interconnection of approved transmitters, meters and other devices in combinations which have not been specifically examined by FM, provided that the agency's criteria are met. The combination is then intrinsically safe, if the entity concept is acceptable to the authority having jurisdiction over the installation.

The entity concept criteria are as follows:

The intrinsically safe devices, other than barriers, must not be a source of power.

The maximum voltage $U_i(V_{MAX})$ and current $I_i(I_{MAX})$, and maximum power $P_i(P_{MAX})$, which the device can receive and remain intrinsically safe, must be equal to or

greater than the voltage (U_0 or V_{oc} or V_t) and current (I_0 or I_{sc} or I_t) and the power P_0 which can be delivered by the barrier.

The sum of the maximum unprotected capacitance (C_i) for each intrinsically device and the interconnecting wiring must be less than the capacitance (C_s) which can be safely connected to the barrier.

The sum of the maximum unprotected inductance (L_i) for each intrinsically device and the interconnecting wiring must be less than the inductance (L_s) which can be safely connected to the barrier.

The entity parameters U_0, V_{oc} or V_t and I_0, I_{sc} or I_t , and C_s and L_s for barriers are provided by the barrier manufacturer.

CSA Installation Drawing 6335QC02.

6335D transmitters are approved as intrinsically safe in Zone 0 Group IIC or Class I, Division 1, Group A, B, C, D when installed according to Installation Drawing.

1. Connections with separate power supply and receiver.

Output: Standard 4 - 20mA loop

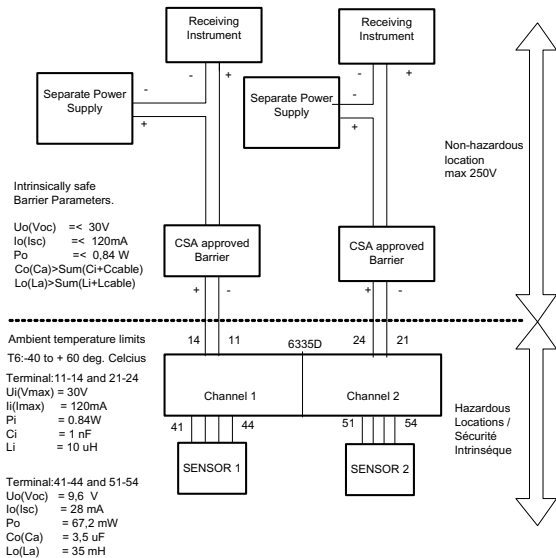

Warning:

Substitution of components may impair intrinsic safety.

Channel 1 and Channel 2 are separate channels and therefore separate shielded cables shall be used for each channel.

The 6335 must be installed in a suitable enclosure to meet installation codes stipulated in the Canadian Electrical Code (CEC).

2. Connection with power supply and barrier built into receiver.

Output: Standard 4 - 20mA loop

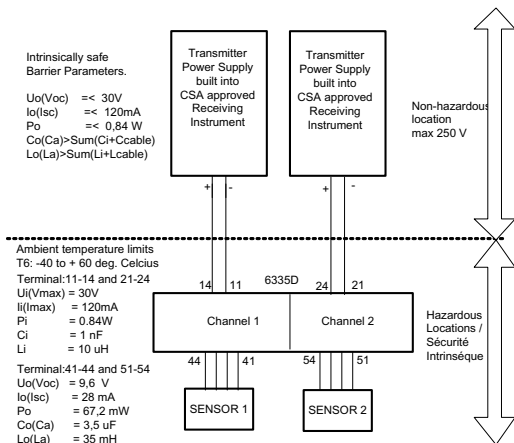

Warning:

Substitution of components may impair intrinsic safety.

Channel 1 and Channel 2 are separate channels and therefore separate shielded cables shall be used for each channel.

The 6335 must be installed in a suitable enclosure to meet installation codes stipulated in the Canadian Electrical Code (CEC).



Displays Programmable displays with a wide selection of inputs and outputs for display of temperature, volume and weight, etc. Feature linearisation, scaling, and difference measurement functions for programming via PReset software.



Ex interfaces Interfaces for analogue and digital signals as well as HART® signals between sensors / I/P converters / frequency signals and control systems in Ex zone 0, 1 & 2 and for some modules in zone 20, 21 & 22.



Isolation Galvanic isolators for analogue and digital signals as well as HART® signals. A wide product range with both loop-powered and universal isolators featuring linearisation, inversion, and scaling of output signals.





















Temperature A wide selection of transmitters for DIN form B mounting and DIN rail modules with analogue and digital bus communication ranging from application-specific to universal transmitters.



Universal PC or front programmable modules with universal options for input, output and supply. This range offers a number of advanced features such as process calibration, linearisation and auto-diagnosis.



PPR®

- 
 www.preelectronics.fr
 sales@preelectronics.fr
- 
 www.preelectronics.de
 sales@preelectronics.de
- 
 www.preelectronics.es
 sales@preelectronics.es
- 
 www.preelectronics.it
 sales@preelectronics.it
- 
 www.preelectronics.se
 sales@preelectronics.se
- 
 www.preelectronics.co.uk
 sales@preelectronics.co.uk
- 
 www.preelectronics.com
 sales@preelectronics.com

Head office

Denmark
 PR electronics A/S
 Lerbakken 10
 DK-8410 Rønde

www.preelectronics.com
sales@preelectronics.dk
 tel. +45 86 37 26 77
 fax +45 86 37 30 85



QUALITY SYSTEM AND ENVIRONMENTAL MANAGEMENT SYSTEM
 DS/EN ISO 9001
 DS/EN ISO 14001

